



CoolMax SRX-R Charge Controller

Installation and Operation Manual



Models

SRX-R 600/60-48



About AERL

Australian Energy Research Laboratories (AERL) was founded by Stuart Watkinson (BE Elec. Eng., Grad. M.I.E.A) in 1985 to commercialize the “Power Optimizer”, a revolutionary solution to a complex problem, developed while studying at the University of Queensland in Brisbane, Australia.

Unlike many inventors, Stuart possessed not only a great idea but also the entrepreneurial skill to turn it into a commercially viable product. The “Power Optimizer” would eventually come to be known as the AERL MAXIMIZER™, the world’s first truly Universal Maximum Power Point Tracker (MPPT).

Today, AERL manufactures a range of highly reliable and efficient specialized power electronic controllers for use in Solar, Micro Hydro, Micro Wind, and Cathodic Protection applications.

Contact Information

Address: 2/75 Bluestone Circuit,
Seventeen Mile Rocks, 4073,
Queensland, Australia

Phone: [+61 1800 950 865](tel:+611800950865)

Email: sales@aerl.com.au

Website: <https://www.aerl.com.au>

Disclaimer

UNLESS SPECIFICALLY AGREED TO IN WRITING, AUSTRALIAN ENERGY RESEARCH LABORATORIES:

(a) MAKES NO WARRANTY AS TO THE ACCURACY, SUFFICIENCY OR SUITABILITY OF ANY TECHNICAL OR OTHER INFORMATION PROVIDED IN ITS MANUALS OR OTHER DOCUMENTATION.

(b) ASSUMES NO RESPONSIBILITY OR LIABILITY FOR LOSS OR DAMAGE, WHETHER DIRECT, INDIRECT, CONSEQUENTIAL, OR INCIDENTAL, WHICH MIGHT ARISE OUT OF THE USE OF SUCH INFORMATION.

THE USE OF ANY SUCH INFORMATION WILL BE ENTIRELY AT THE USER’S RISK.

Notice of Copyright

CoolMax SRX-R Charge Controller User Manual © 2024 by AERL Pty. Ltd. All Rights Reserved.

Trademark

AERL and the AERL Logo are trademarks owned by AERL Holdings Pty. Ltd. and used by AERL Pty. Ltd under license.

These trademarks may be registered in Australia and other countries.

Effective Date

November 2024 (11/2024)

Table of Contents

Warranty Conditions.....	5
Specifications.....	6
Introduction.....	7
Features.....	7
Firmware.....	7
Installation.....	8
Standards & Requirements.....	8
Grounding.....	8
Mounting the Shelf.....	9
Wiring Information.....	10
Wire and Disconnect Sizing.....	10
CoolMax SRX-R 600/60-48.....	10
Backplane Terminations.....	11
Operation.....	12
Start-Up & Shutdown Procedure.....	12
Programming the Device.....	12
Device Status Indicator.....	13
Battery Charge Profile.....	14
Charge Profile Configuration.....	15
Setting the Battery Charge Profile with AERL Link.....	16
Ground Fault Detection.....	18
Ground Fault Sensitivity.....	19
Communications Protocols.....	20
Troubleshooting – Error Codes.....	21

Important Safety Information

This Installation Manual contains important safety information and installation instructions for the AERL COOLMAX SRX-R MPPT Solar Charge Controller.

The following symbols are used throughout this user manual to indicate ideal installation methods, potentially dangerous conditions, and important operational information.



IMPORTANT

Indicates information that must be followed to ensure proper operation of the COOLMAX SRX-R.



CAUTION

Indicates a critical procedure for the safe installation of the COOLMAX SRX-R. Use extreme caution when performing this task.

About this Manual



IMPORTANT

- This User Manual provides detailed installation and usage instructions for the COOLMAX SRX-R unit. It is recommended that all the Instructions and Cautions in this User Manual be read before beginning installation.
- Only qualified electricians and technicians should install the COOLMAX SRX-R. This manual is intended for all installation technicians and the system owner.
- Do not disassemble or attempt to repair the COOLMAX SRX-R unless you are a qualified technician and have authority in writing from AERL to do so.
- AERL will not be held responsible in any way for the mishandling of this product or for installation of the product in a manner that does not follow the instructions in this manual or as advised by an AERL technician.

Warranty Conditions

¹ Warranty Duration from the Date of Purchase

Warranty Requirements	Total Warranty Duration
1. You are the original purchaser of the CoolMax SRX-R.	5 Years
2. You are the original purchaser of a CoolMax SRX-R, and you have purchased the Plus 5 warranty extension from AERL.	10 Years

Our goods come with guarantees that cannot be excluded under the Australian Consumer Law. You are entitled to a replacement or refund for a major failure and compensation for any other reasonably foreseeable loss or damage. You are also entitled to have the goods repaired or replaced if the goods fail to be of acceptable quality and the failure does not amount to a major failure.

AERL will bear the cost of parts and labour to repair any manufacturing faults found within the terms and period of this warranty and pay the cost of freight to return the repaired CoolMax SRX-R controller within Australia/New Zealand, but the method of freight will be determined by AERL.

An allowance is made for the labour required to disconnect or reinstall faulty parts up to the value of \$220 AUD excluding GST.

All installation and user conditions as set down in the instruction manual must be strictly adhered to as failure to do so may void your warranty. Any faults or like faults caused by lightning, water or moisture ingress, vermin infestation, improper voltage, faulty installation, use of the product in a manner for which it is not intended, alterations which affect the reliability or performance of the unit but are not attributable to faulty manufacture, or damage caused by other system components will not be covered under warranty.

In the event of the product being out of service, AERL shall bear no responsibility for any consequential loss or expense. AERL will not be held responsible for any misleading or incorrect information conveyed by anyone not directly employed by AERL.

For claims under warranty, the faulty product(s) must be returned to AERL's facility at 2/75 Bluestone Circuit, Seventeen Mile Rocks, 4073, QLD, Australia after contacting AERL and receiving the appropriate RMA documentation from AERL.

AERL can be reached at 1800 950 865 or at support@aerl.com.au for assistance with this process.

Specifications

General Specifications	
Parameter	Typical
Weight	6.2 kg
Dimensions (H x W x D)	432 x 192 x 78 mm
Enclosure Type	Indoor Type 1 / IP20
Input / Output Power Connectors	Backplane Connector

Characteristics	SRX-R 600/60-48
Nominal Battery Voltage / Vdc Range	48 V / 20 - 60
Max Charge Current	60A
Nominal Charge Power	3456 W @ 48 V
Max PV Input Power	Nominal Charge Power x 1.5
Max PV Input Voltage (Voc)	600 V
MPP Voltage Range (Vmp)	170 – 500 V
Min PV Operating Voltage	100 V
Max PV Input Current (Imp)	14 A
Max PV Short Circuit Current (Isc)	20 A
Device Startup Voltage	60 V
Total Backfeed Current (Ibf Total)	0 A
Overload Behaviour	Power Limitation
PV Reverse Polarity Protection	Yes
Earth Leakage Current Detection	Yes
Overvoltage Category	DC II
Overvoltage Protection	DC Type II
Safety Protection Class	I
Pollution Degree (Int & Ext)	I
Max Altitude Rating	2000m
Max Conversion Efficiency	96%
Ambient Operating Temperate Range (Maximum Charge Current derates by up to 10% Per ° C above 80% Ambient ° C)	-20 to +50 °C
Storage Temperature	-30 to +70 °C
Self-Consumption @ Idle	3.5 W
Allowable Relative Humidity	4 – 95% (non-Condensing)
Cooling Method	Active (User Serviceable)
Required Cabinet Air Exchange Rate (Intake @ 40 °C)	25 M ³ / Hour
Communications	RS485 / CAN Bus
Certifications	IEC62109-1:2010 EN61000.6.3:2012 EN61000.6.4:2012

Introduction

Thank you for purchasing an Australian-made CoolMax SRX-R Series Charge Controller.

CoolMax Charge Controllers offer an efficient and reliable charging process that maintains battery efficiency and life and maximizes power generation by utilising the full potential of your PV array.

Features

CoolMax Charge Controllers utilise an advanced form of Maximum Power Point Tracking (MPPT) technology to extract the maximum power available from your PV array, efficiently charging your batteries and maximizing power generation.

AERL's Maximum Power Point Tracking (MPPT) algorithm has been proven to be highly robust, resistant to local extremes, and results in power losses of less than 0.5% over a PV array's whole operating temperature range.

- High Input Voltage for Ease of Install
- On-Board Ground Fault Detection
- PV Array Oversizing Support (+50%)
- Superior Peak Power Efficiency
- Built-In Overload and Thermal Protection
- Reverse Polarity and Current Protection
- Designed for Long Term Reliability
- Australian Made

Firmware

This user manual covers CoolMax SRX-R Control Firmware Revisions v2.6 and above.

Installation



IMPORTANT

The SOLAR DC ISOLATOR/BREAKER at the input side must be in the OFF position before connecting or disconnecting the MPPT Charge Controller.



CAUTION – Equipment Damage

CoolMax Charge Controllers are not designed to be used in parallel with other Third-Party Charge Controllers and this will void your warranty.

Standards & Requirements

All installations must comply with national and local electrical standards and codes of practice, and the CoolMax SRX-R must be installed in a clean, dry location away from direct sunlight. AERL always recommends professional installation. No on-going maintenance is required.

Grounding

CoolMax Charge Controllers are designed to be installed in floating systems but contain provisions for positive functional earthing for telecom applications if required.



CAUTION – Hazard

DO NOT FUNCTIONALLY EARTH THE ARRAY if a negative earth is used for the batteries, load, or DC system.



IMPORTANT

The Chassis Ground (located inside the enclosure) is marked with the following symbol:



CAUTION – Hazard

If damaged or malfunctioning, the AERL controller should only be disassembled and repaired by a qualified service centre. Please contact your local authorized distributor for assistance.

Incorrect reassembly risks malfunction, electric shock, or fire.

Mounting the Shelf

The SRX-R shelf must be mounted horizontally in a suitably ventilated lockable IP5X cabinet ensuring the backplane area is restricted to licensed electricians and qualified technicians.

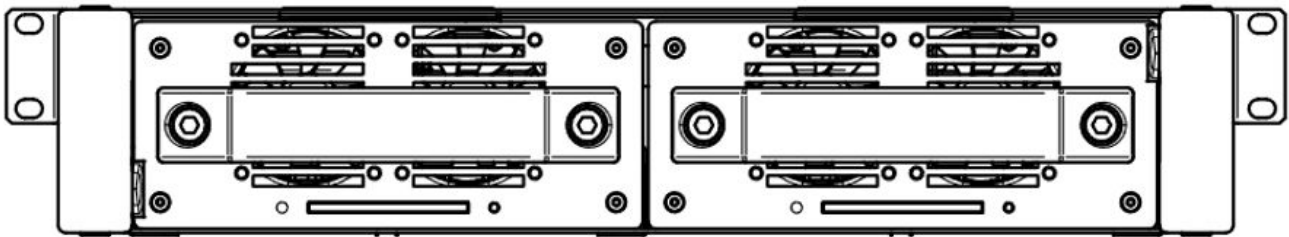

Figure 1: SRX-R Modules in Shelf

Wiring Information

This section will provide information and instructions for safely wiring up the DC connections on the CoolMax SRX-R.

Wire and Disconnect Sizing



IMPORTANT

- Wire sizes must comply with local and national standards. Input conductors and circuit breakers must be rated at 1.56 times the short-circuit current of the PV array.
- Copper wiring must be rated at 75°C or higher.

Use a minimum of #6 AWG (16 mm²) wire for the output between the backplane and the battery bus bar or termination, and use an appropriately sized insulated crimp ferrule when terminating both the input and output connections.

The connection between the SRX-R Shelf and protective earth should be at least #12 AWG (4mm²).

Torque all CoolMax wire and ground terminals to 1.7 Nm (15 in-lb).

CoolMax SRX-R 600/60-48

- The CoolMax SRX-R 600/60-48 output current limit is 60 amps per module.
- Use a **160A+** Non-Polarized DC **Circuit Breaker** between the shelf output and load.
 - **Recommended Option:** Noark Ex9MD 160A DC MCB

Please refer to the relevant IEC or AS/NZS electrical code for PV array cable sizing, length, and ampacity recommendations.

All devices connected to the controller must have suitable insulation in accordance with the relevant product standards.

Backplane Terminations



CAUTION – Equipment Damage

Reversing the polarity of the output may damage the CoolMax SRX-R and void product warranty.

Confirm polarity with a multi-meter prior to closing the input and output

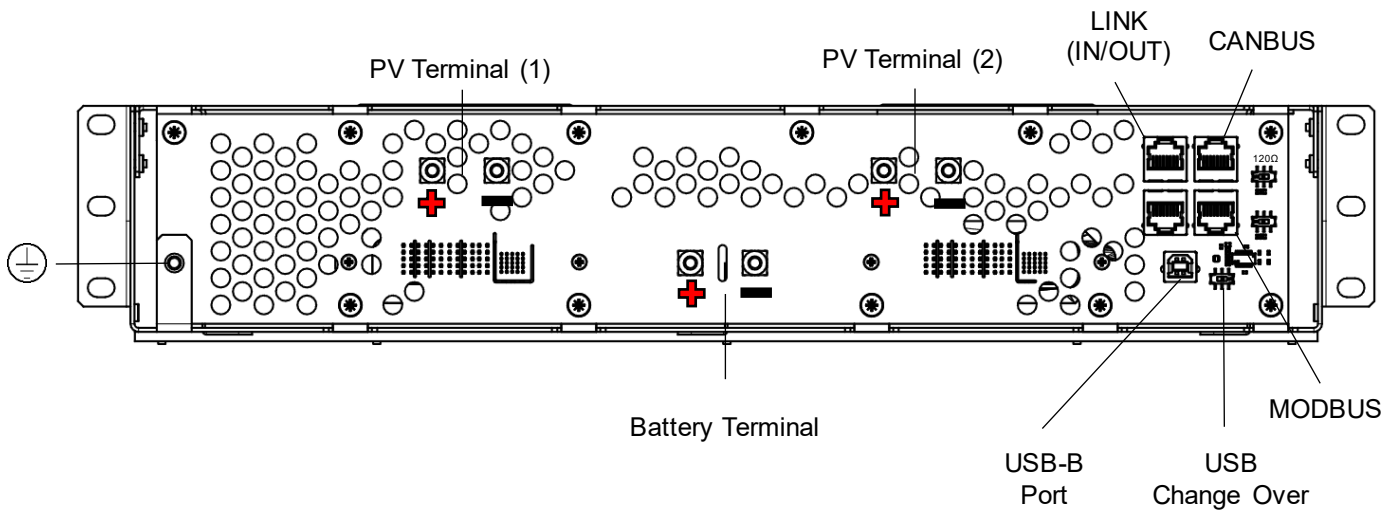

Figure 2: SRX-R Backplane

Operation

Start-Up & Shutdown Procedure

The CoolMax SRX-R will start-up when a voltage above 60Vdc is applied to the PV Input – *The device will not power up from the Battery terminal.*

To start the device, connect the Battery first, and then turn the PV Isolator/Breaker on. The LED will flash blue for approximately 60 seconds, and then begin to charge – USB setup **will be required** on first start-up.

To shut down the device, turn the PV Isolator off, wait for the LED to turn off, and then disconnect the battery breaker to isolate the controller.



CAUTION – Equipment Damage

Do not remove an SRX-R MPPT from the backplane while charging – Turn off the PV isolator first to prevent equipment damage.

Programming the Device

When the CoolMax SRX-R is first powered on, the device will run a self-test, and then the LED indication strip will flash yellow to indicate no charge profile has been configured.

The CoolMax SRX-R is programmed via the **USB-B** port located on the backplane board as demonstrated in **Figure 4** to the right.

Note - The USB Selection Switch must be toggled between MPPT 1 and MPPT 2.

The AERL Link Software for Windows 10/11 can be downloaded at the URL below.

link.aerl.com.au

Instructions for setting the charge profile located on **Page 16**.

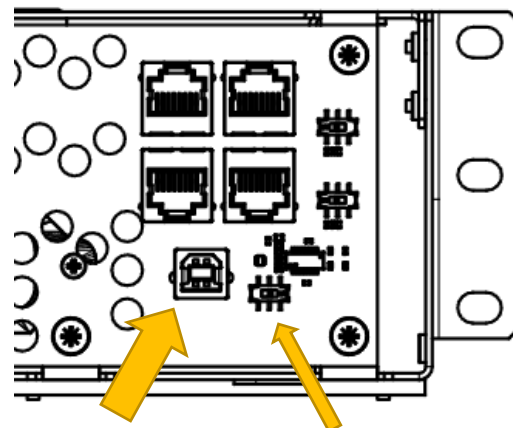
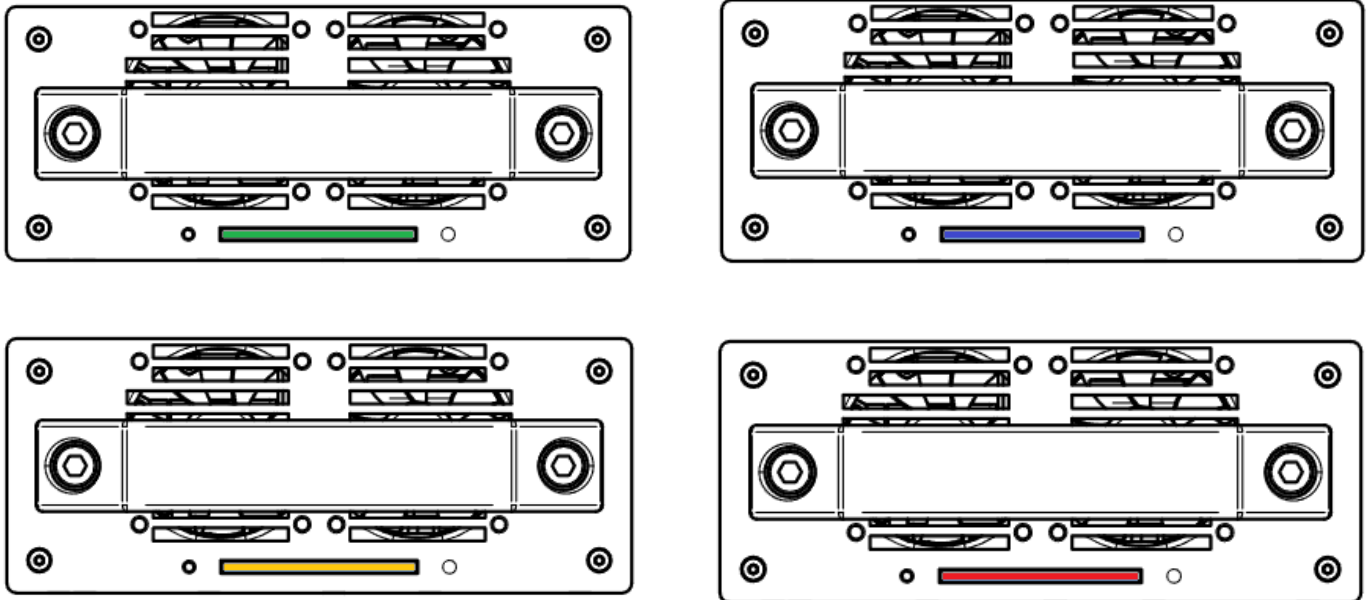

Figure 3: USB-B Programming Port and Toggle Switch

Device Status Indicator



Green	OK
Blue	START-UP / SLEEP
Yellow	CHARGER DISABLED / SETUP REQUIRED
Red	FAULT

Figure 4: LED Indication States

Battery Charge Profile



IMPORTANT

The CoolMax SRX-R default charge profile is intended for a generic LiFePo₄ battery solution.

AERL supports most other battery chemistries that **do not** require external BMS communications.

AERL is working with various battery manufacturers to expand out-of-the-box comms support for Lithium batteries that require communication with the Charge Controller.

Please contact AERL support to confirm compatibility prior to installation. Additional battery support will be rolled out via Over-The-Air firmware updates.

For safety reasons, the CoolMax SRX-R charge output will not automatically activate. Before activating the charge output, the charge profile must be configured for the relevant battery solution being utilized.

The SRX-R operates using an advanced three-stage charging process and has pre-set charge voltage profiles for each supported nominal battery voltage. That said, AERL always recommends referring to the battery manufacturer’s specifications regarding charge voltages for optimal battery life and performance.

These voltages can be adjusted in the charge profile settings. Refer to **Page 16** for instructions.

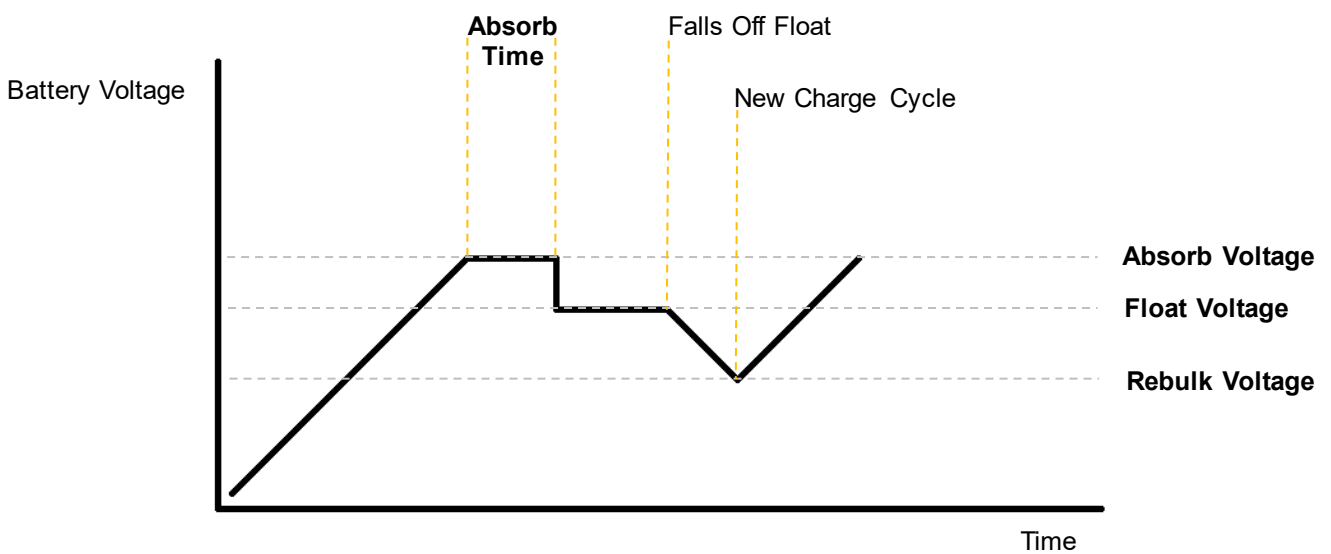

Figure 5: Battery Charge Profile Illustrated

Charge Profile Configuration

The CoolMax SRX-R allows for extensive flexibility when it comes to charge profile parameters to suit numerous different modern battery chemistries and manufacturers requirements.

Our programmable charge profile allows for the configuration of the Battery Charge Rate, and the Absorb, Float, Re-Bulk, and Equalization voltage points.



IMPORTANT

An Equalization is only normally required for Flooded Lead-Acid cells that experience sulfation because of poor charging practices over the lifetime of said cell.

Equalization is **not required, nor recommended** for LiFePo4 or other lithium-based battery solutions and will likely cause damage unless otherwise advised by the battery manufacturer.

The default charge profile is suitable for most applications but to determine the optimal charge profile for your application, please refer to your battery manufacturer’s user manual or datasheet.

The **CoolMax SRX-R** Default Charge Profiles are as follows:

	SRX-R 600/60-48
Nominal Battery voltage	48 V
Max Charge current	60 A
Absorption voltage	56 V
Absorption time	2 Hours
Float Voltage	55.2 V
Re-Bulk Voltage	52 V

Setting the Battery Charge Profile with AERL Link

Connect to the **USB-B Port** on the backplane, ensuring the USB Change-Over Switch (refer to Figure 2 on Page 11) is set to the device you wish to program. Within a few seconds, the device will appear in the available local devices list in AERL Link.



Click on the Device, select the **Settings** button on the device page to access the battery charging settings. Charge settings are changed by clicking on the setting value and using the plus/minus arrows or the keyboard to enter a new value.

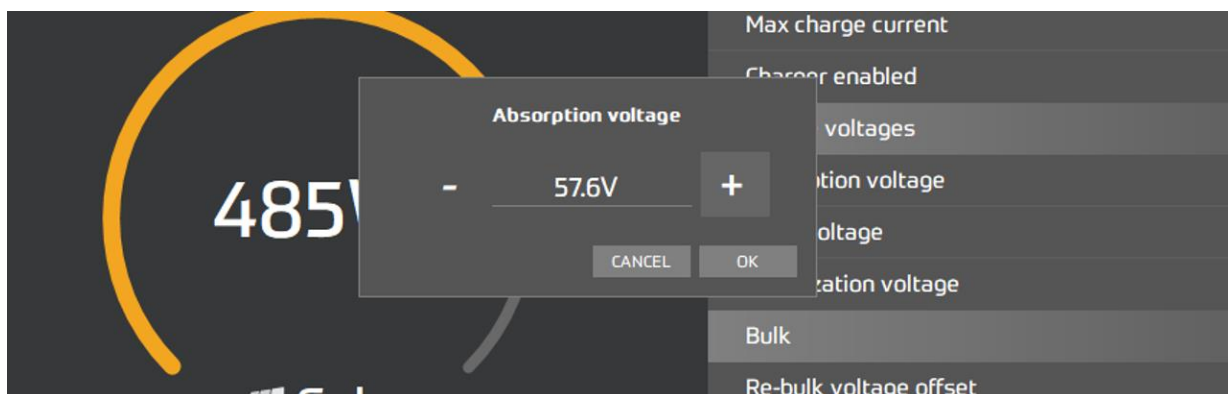

Once the required settings have been set, slide the charger-enabled toggle to the right and **apply the changes** to the CoolMax SRX-R by clicking the **Apply** button to begin charging.

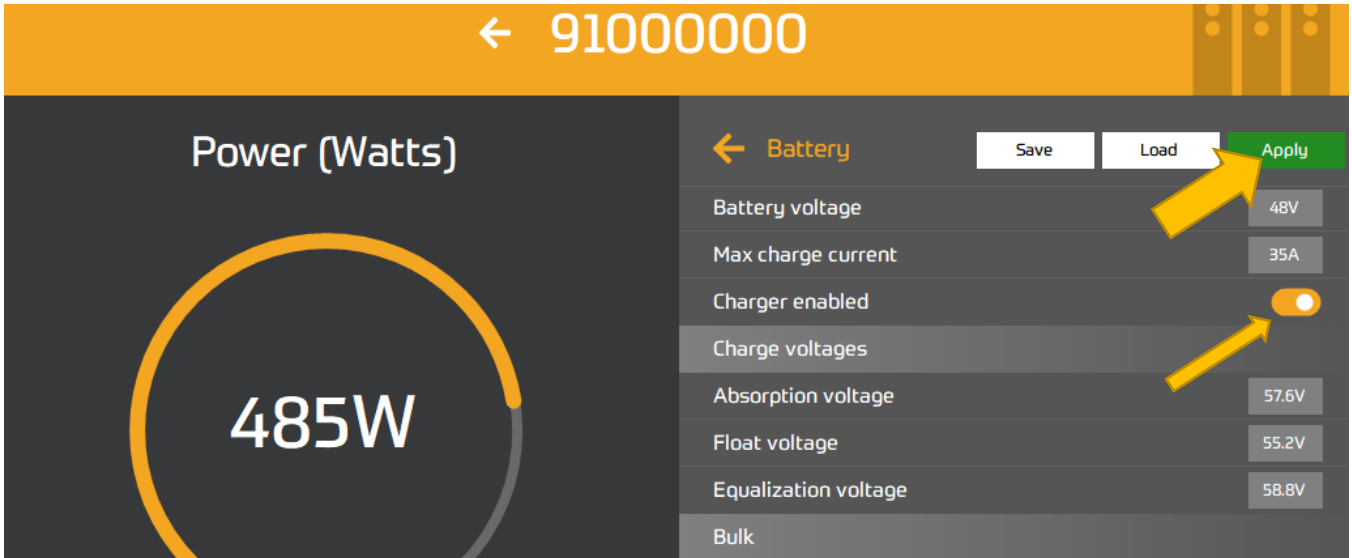

Ground Fault Detection

The CoolMax SRX-R features industry-first onboard PV and Battery system ground fault detection, with all connected electrical poles checked for insulation degradation during the device's start-up routine.

The device chassis **must** be connected to the same earth as the PV array for the ground fault detection to function. The chassis earth point is located inside the access cover and is indicated with the symbol demonstrated below.

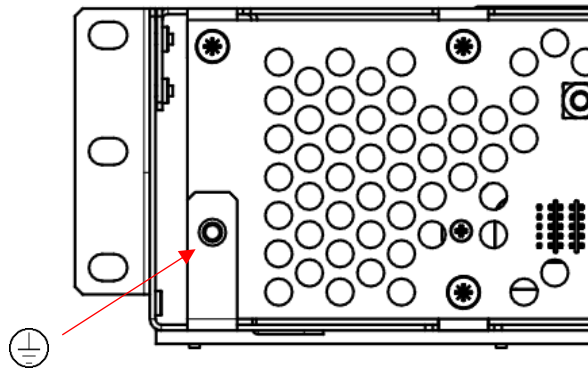

Figure 10: Chassis Earth Point



IMPORTANT

The system earth configuration (**Ground Fault Mode**) must be adjusted in the AERL Link software for use with functionally earthed systems otherwise an earth fault will be detected on the earthed pole.

Ground Fault Sensitivity

The SRX-R ground fault detection offers three levels of sensitivity, all of which are compliant with the Australian PV installation standards.

Low	100kΩ
Medium	50kΩ
High	30kΩ

The sensitivity of the ground fault detection can be configured in AERL Link as demonstrated in **Figure 11** below.

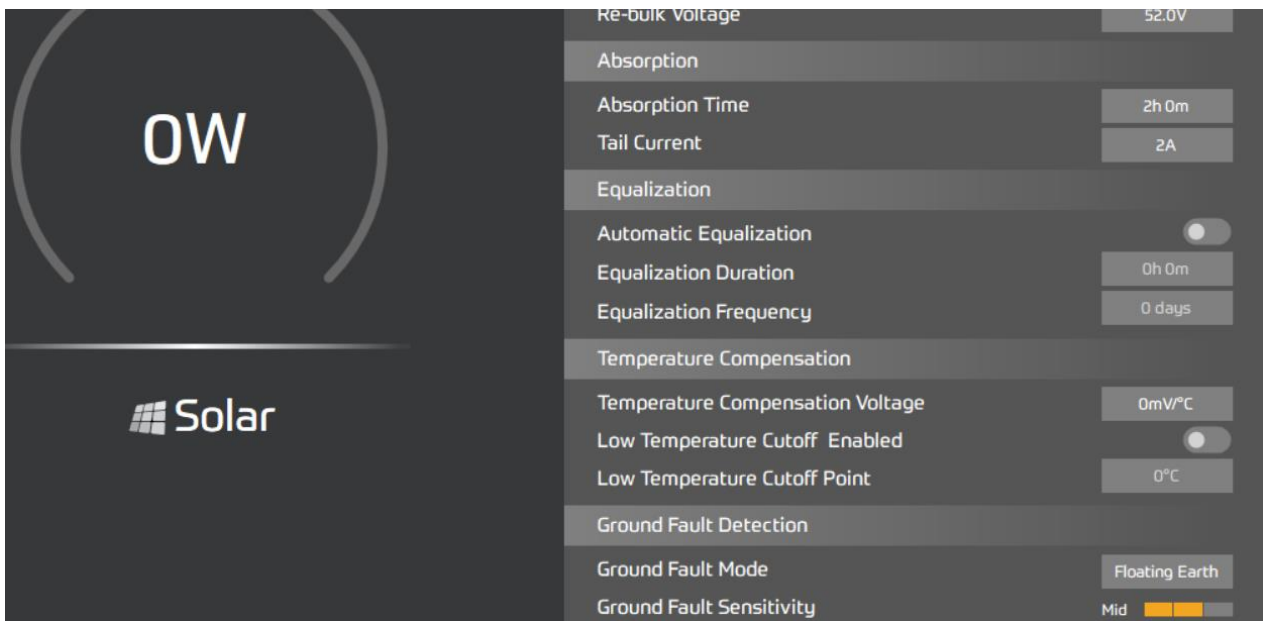

Figure 11: Ground Fault Sensitivity Adjustment

Communications Protocols

The CoolMax SRX-R features both Controller Area Network (**CAN bus**) and Modbus RTU (**RS485**) compatible protocols for remote monitoring and control functionality. AERL can provide the relevant protocol registry maps for integration upon request.

Both networking protocols can be accessed via the RJ45 connectors located on the backplane.

The pinouts for these connections are demonstrated in **Figure 12** below.

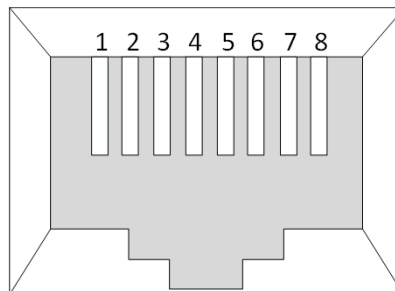

Pin	RS485 Connector
3	RS485 A
6	RS485 B
1, 2, 4, 5, 7, 8	GND

Pin	CAN Connector
3	+5V
4	CAN High
5	CAN Low
6	GND

Figure 12: Comms Connector Pinouts

Troubleshooting – Error Codes

If the CoolMax SRX-R detects an issue, a warning, or fault code will be triggered.

Please refer to the table below for Warning Codes and the tables located on **Page 25 & 26** for Fault Codes.

Warning Code	LED Code	Warning	Description	Recommended Action
-26	Flashing Yellow/Green	Device Not Configured	The initial setup process has not been completed and the device will not begin charging.	<i>Connect and configure the device with the AERL Link Software. Refer to Page 14.</i>
-1303	Solid Yellow/Green	Charger Disabled	The charger has been disabled via the Settings in AERL Link.	<i>Connect to the device and enable the charger to begin charging.</i>
-1153	Solid Blue	Low Input Voltage Detected (Sleep Mode)	The PV Voltage is below the minimum allowed PV Voltage or not adequate to charge the connected battery.	<i>Confirm PV String Configuration is appropriate for the device and the sun is shining. Note – This code may be shown during sunrise and sunset conditions.</i>
-1304	N/A	Battery Sense Not Detected	The remote voltage and temperature sensor is either unplugged or faulty.	<i>Refer to Battery Sense User Manual for troubleshooting.</i>
-1301	Flashing Yellow/Green	CAN Master Lost	The device has not received information from the Master within the allowed time-out window.	<i>Confirm your RJ45 connection has not been interrupted and the Master device is still active.</i>
-1160	Flashing Yellow/Green	Configuration Out of Range	Set Point configuration is outside limits and may be dangerous for detected nominal battery voltage.	<i>Confirm the Charge Profile is appropriate for the battery being charged. Refer to the Battery Manufacturer's recommendations.</i>

Please refer to the table below for Fault Codes.

Fault Code	LED Code	Error	Description	Recommended Action
-1 to -100	Solid Red	Generic Hardware Fault	A hardware fault has been detected.	<i>Please contact your distributor to organize a warranty replacement.</i>
-350	1 Flash - Red	No Output Detected	No output has been detected.	<i>Power cycle the device and contact AERL if it reoccurs.</i>
-1100	Solid Red	Internal Temperature Critical	The device's internal systems have reached a critical temperature and shutdown to prevent system damage.	<i>The device will automatically restart when it's safe to do so.</i>
-1159	2 Flashes - Red	Low Output Voltage	Low output voltage has been detected.	<i>Confirm the battery is connected to the controller.</i>
-1154	3 Flashes - Red	High Output Voltage	High output voltage has been detected.	<i>Battery may be being charged from a secondary source. Confirm all system battery charge parameters.</i>
-1157	4 Flashes - Red	High Output Current	High output current has been detected.	<i>Confirm no short circuit is present on the output of the controller.</i>
-1152	5 Flashes - Red	High PV Voltage	High PV Voltage has been detected. The device has shutdown to prevent system damage.	<i>Confirm PV String Configuration is appropriate for the device.</i>
-1156	6 Flashes - Red	High PV Current	High PV input current has been detected.	<i>Confirm PV String Configuration is appropriate for the device.</i>

Fault Code	LED Code	Error	Description	Recommended Action
-1051 -1052	Solid Red	Active Cooling Degraded	Degraded active cooling capability has been detected.	<i>Replace Fan Module.</i>
-1102	8 Flashes - Red	High Battery Temperature Detected	The battery temperature sensor has detected a high battery temperature. Operating the battery at a high temperature will greatly reduce its lifespan.	<i>Consider increasing the battery temperature compensation factor with the AERL Link Software or reducing the ambient environment temperature.</i>
-1103	9 Flashes - Red	Low Battery Temperature Detected	The battery temperature sensor has detected a low battery temperature. Operating the battery at a low temperature may greatly reduce its lifespan.	<i>Consider a temperature-controlled battery environment if the battery regularly experiences low temperatures.</i>
-1401 -1402 -1403	10 Flashes - Red	Earth Fault Detected	An Earth Fault has been detected.	<i>Disconnect the device, confirm the fault with a Megger, and repair the system.</i>